

UNO-3283G/3285G

Intel® Core™ i7/ i5/ i3 Automation Computer with 2/4 PCI(e) Expansion Slots, 2 x GbE, 2 x mPCIe, HDMI, DVI-I

NEW



UNO-3283G

UNO-3285G



Features

- Intel® 6th Gen Core™ i7-6822EQ/ i5-6442EQ/ i5-6440EQ/ i3-6102E Processors with 8GB DDR4 memory
- 2 x GbE, 6 x USB 3.0, 2 x RS-232/422/485, 2 x RS-232 (pin header), 1 x DVI-I, 1 x HDMI
- UNO-3283G: 1 x PCIe x16, 1x PCI, 2 x mPCIe (2 x full), 1x CFast slot, 1 x mSATA slot (optional)
- UNO-3285G: 2 x PCIe x8, 2 x PCI, 2 x mPCIe (2 x full), 1x CFast, slot, 1 x mSATA slot (optional)
- Dual Hot-Swappable storage with thumb screw support for RAID 0/1
- Supports Fieldbus protocol by iDoor technology
- Dual power input for power redundancy
- Optional ECC RAM with selected RAM module
- Front LED indicator design for monitoring system status

Introduction

The high-performance fanless control cabinet PC UNO-3283G/ 3285G equipped with a Intel® 6th Gen Core™ i7/ i5/ i3 processor and QM170 PCH chipset, rich I/O including 6 x USB 3.0, 2 x GigaLAN, 2 x RS-232/422/485, and 2 x RS-232 (pin header) ports, as well as DVI-I and HDMI display interfaces, UNO-3283G/ 3285G is designed to deliver high-performance computing and maximum flexibility for industrial automation applications. The provision of two hot-swappable HDD/SSD bays and up to 5 expansion slots (2 x PCIe x8, 2 x PCI) supports the integration of modular peripherals and ensures flexible installation in diverse cabinet configurations. In addition to an exchangeable RTC battery that can be accessed via the removable top cover for convenient maintenance, the system features dual power inputs that ensure a stable power supply.

Specifications

General

- Certification** CE, UL, CCC, FCC, BSMI
- Dimensions (W x D x H)** UNO-3283G: 142 x 238 x 177 mm (5.6" x 9.4" x 7")
UNO-3285G: 182 x 238 x 177 mm (7.2" x 9.4" x 7")
- Form Factor** Regular Size
- Mounting** Wall mount, Stand mount, Enclosure mount
- Weight (Net)** 4kg (2.2 lbs)/ 4.5kg (9.9 lbs)
- Power Requirements** 10-36 V_{DC}
- Power Consumption** 90W (Typical @ 24V); 133W (Max. @ 24V)
- OS Support** WIN7/8, WES7, Win10 Ent. LTSB, AdvLinuxTU

System Hardware

- BIOS** AMI UEFI 128Mbit Flash BIOS
- Watchdog Timer** Programmable 255 levels timer interval, from 1 to 255 sec
- Processor** Intel® Core™ i7-6822EQ 2.0GHz Quad Core, 8MB L2
Intel® Core™ i5-6442EQ 1.9GHz Quad Core, 6MB L2
Intel® Core™ i5-6440EQ 2.7GHz Quad Core, 6MB L2
Intel® Core™ i3-6102E 1.9GHz Dual Core, 3MB L2
- System Chip** Intel QM170
- Memory** Built-in 8GB DDR4 2133 MHz, two sockets support up to 32GB (Optional ECC RAM with selected RAM module for UNO-3283G-634AE/ UNO-3285G-634AE)
- Graphics Engine** Intel HD Graphics
- Ethernet** LAN A: Intel® i210-IT GbE, IIEEE802.1AS, 802.3az
LAN B: Intel® i219-LM GbE, Intel® AMT, IEEE802.1AS, 802.3az LEDs for Power, LAN, COM (Tx/Rx), battery and HDD
- LED Indicators** One mSATA slot; One CFast slot (sh)
- Storage** Two built-in 2.5" SATA HDD brackets with support for RAID 0/1. (Compatible with 9.5mm height HDD)
- Expansion** UNO-3283G: 2 Full-size mPCIe, 1 x PCIe x16, 1 x PCI (Optional by project: 2 x PCIe x8 or 2 x PCI)
UNO-3285G: 2 Full-size mPCIe 2 x PCIe x8, 2 x PCI (Optional by project: 4 x PCI)

I/O Interfaces

- Serial Ports** 2 x RS-232/422/485 with DB9 connectors
RS-485 auto flow control, 50-115.2kbps, 2 x RS-232 (optional pin header)
- LAN Ports** 2 x RJ45, 10/100/1000 Mbps IEEE 802.3u 1000BASE-T Fast Ethernet
- USB Ports** 6 x USB 3.0 Ports
- Displays** 1 x DVI-I, supports 1920 x 1080 @ 60Hz 24bpp
1 x HDMI 1.4a, supports 1920 x 1080 @ 60Hz 24bpp
- Audio** Mic-in, Line-In, Line-Out (Pin Header)
- Power Connector** 2 x 3 Pin, terminal Block to support dual power input and relay output

Environment

- Operating Temperature** -20 ~ 60°C (-4 ~ 140°F) with 0.7m/s airflow environment
0-50°C (32 ~ 122°F) for UNO-3283G-6541AE
- Storage Temperature** -40 ~ 85°C (-40 ~ 185°F)
- Relative Humidity** 10 ~ 95% RH, non-condensing
- Shock Protection** Operating, IEC 60068-2-27, 50G, half sine, 11ms (SSD)
- Vibration Protection** Operating, IEC 60068-2-64, 4Grms, random, 5 ~ 500Hz, 1hr/axis (SSD); 1.5Grms, random, 5 ~ 500Hz, 1hr/axis (HDD)

Installation Scenario

Stand mount

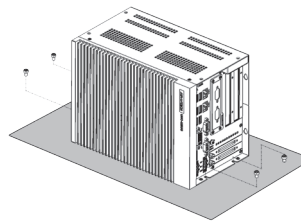

Wall mount

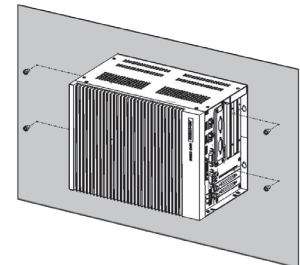

Enclosure Mount

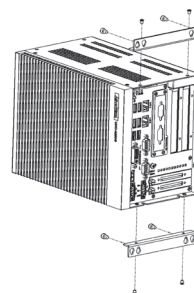

Wall mount

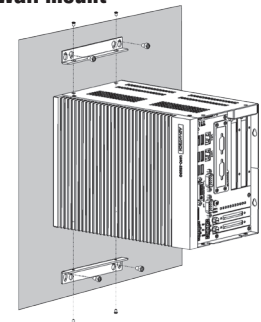

*Mounting kit included in default package

Dimensions

Unit: mm

UNO-3283G

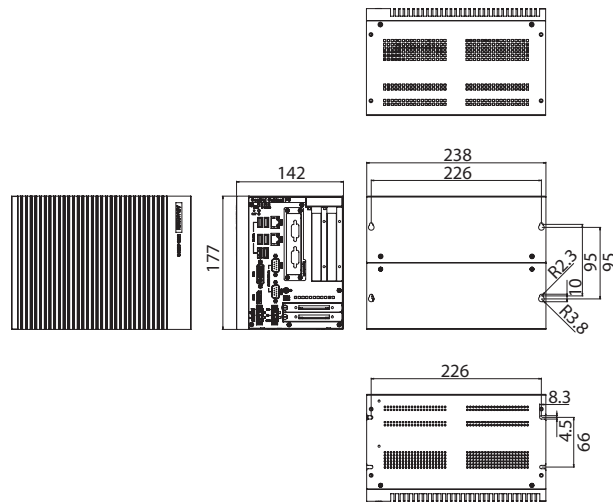

UNO-3285G

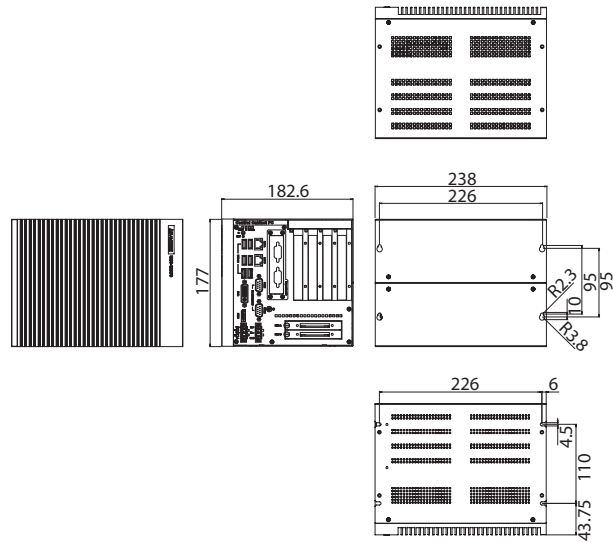

I/O View

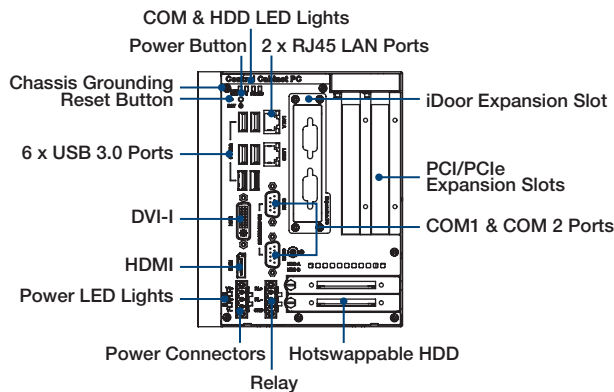

Ordering Information

- UNO-3283G-674AE Intel Core™ i7-6822EQ 2.0GHz, 8GB, 2 x LAN, 1 x PCIe x16, 1 x PCI, 2 x Full-size mPCIe
- UNO-3283G-654AE Intel Core™ i5-6442EQ 1.9GHz, 8GB, 2 x LAN, 1 x PCIe x16, 1 x PCI, 2 x Full-size mPCIe
- UNO-3283G-6541AE UNO-3283G w/ i5-6440EQ, 1 x PCI, 1 x PCIe x16
- UNO-3283G-634AE Intel Core™ i3-6102E 1.9GHz, 8GB, 2 x LAN, 1 x PCIe x16, 1 x PCI, 2 x Full-size mPCIe
- UNO-3285G-674AE Intel Core™ i7-6822EQ 2.0GHz, 8GB, 2 x LAN, 2 x PCIe x8, 2 x PCI, 2 x Full-size mPCIe
- UNO-3285G-654AE Intel Core™ i5-6442EQ 1.9GHz, 8GB, 2 x LAN, 2 x PCIe x8, 2 x PCI, 2 x Full-size mPCIe
- UNO-3285G-634AE Intel Core™ i3-6102E 1.9GHz, 8GB, 2 x LAN, 2 x PCIe x8, 2 x PCI, 2 x Full-size mPCIe

Optional Expansion Type

P/N	Support Model	Expansion Type
9893U20500E	UNO-3285G	4 x PCI slot
9893U20700E	UNO-3283G	2 x PCI slot
9893U20800E	UNO-3283G	2 x PCIe x8 slot

* By project support

iDoor Modules

- PCM-2300MR-AE MR4A16B, MRAM, 2 MByte, mPCIe
- PCM-24R2PE-AE Intel i350, GbE, PoE IEEE 802.3af, PD, RJ45 x 2
- PCM-24S2WF-BE 802.11 a/b/g/n/ac 2T2R w/BT4.1, Atheros QCA6174A
- PCM-26D2CA-AE SJA1000 CANbus, CANopen, DB9 x 1
- PCM-24D2R4-BE 2-Ports Isolated RS-422/485 mPCIe, DB9
- PCM-24D2R2-BE 2-Ports Isolated RS-232 mPCIe, DB9
- PCM-24D4R4-BE 4-Ports Non-Isolated RS-422/485 mPCIe, DB37
- PCM-24D4R2-BE 4-Ports Non-Isolated RS-232 mPCIe, DB37
- PCM-27D24DI-AE 24-Channels Isolated Digital I/O with counter mPCIe, DB37
- PCM-24R1TP-AE 1-Port Gigabit Ethernet, Intel® 82574L, mPCIe, RJ45

Optional Accessories

- 96PSA-A150W24T2 150W AC to DC power adapter
- 1702002600 Power Cable US Plug 1.8 M
- 1702002605 Power Cable EU Plug 1.8 M
- 1702031801 Power Cable UK Plug 1.8 M
- 1700000596 Power Cable China/Australia Plug 1.8 M
- UNO-3283EM-AE Extra 2 x COM ports extension kit
- UNO-3283PR-AE Remote Power & Reset extension kit

Embedded O/S

- 2070014861 Img WIN10ENT 2016LTSB V6.01 B019 UNO-328xG-67xAE
- 2070014706 WES7P x64 MUI V4.14 B002 for UNO-328xG Image